

主机型号: EX3U-32MR/MT/MRT

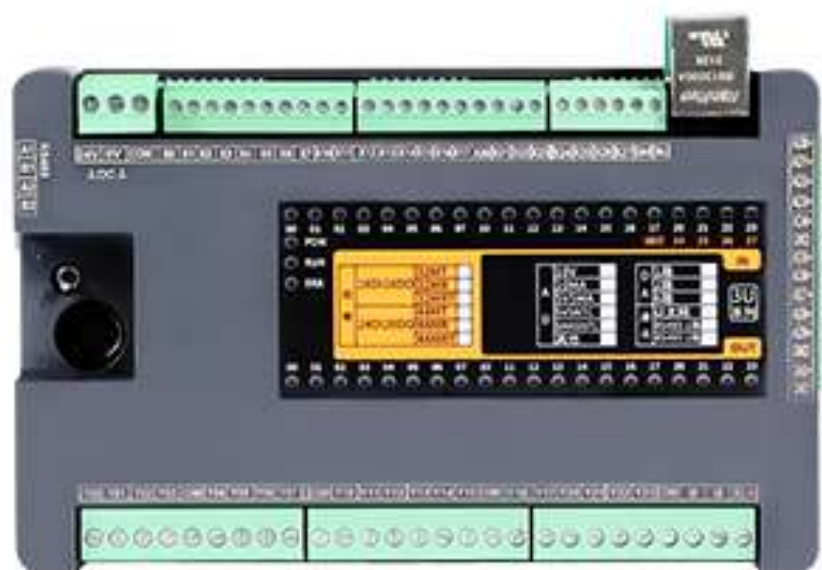

安装尺寸: 166x105x47MM

产品信息	PRODUCT INFO
品牌	易控王 Easycon
产品型号	EX3U-32MR/MT/MRT
供电电压	DC24V
开关量	16进16出
可选配模拟量	10路输入/1路输出
高速脉冲输入	2路110K AB向/单向6路
高速脉冲输出	6轴200K/2轴100高速脉冲输出
可选装	10AD-1DA

## EX3U-32-10AD-1DA接线图

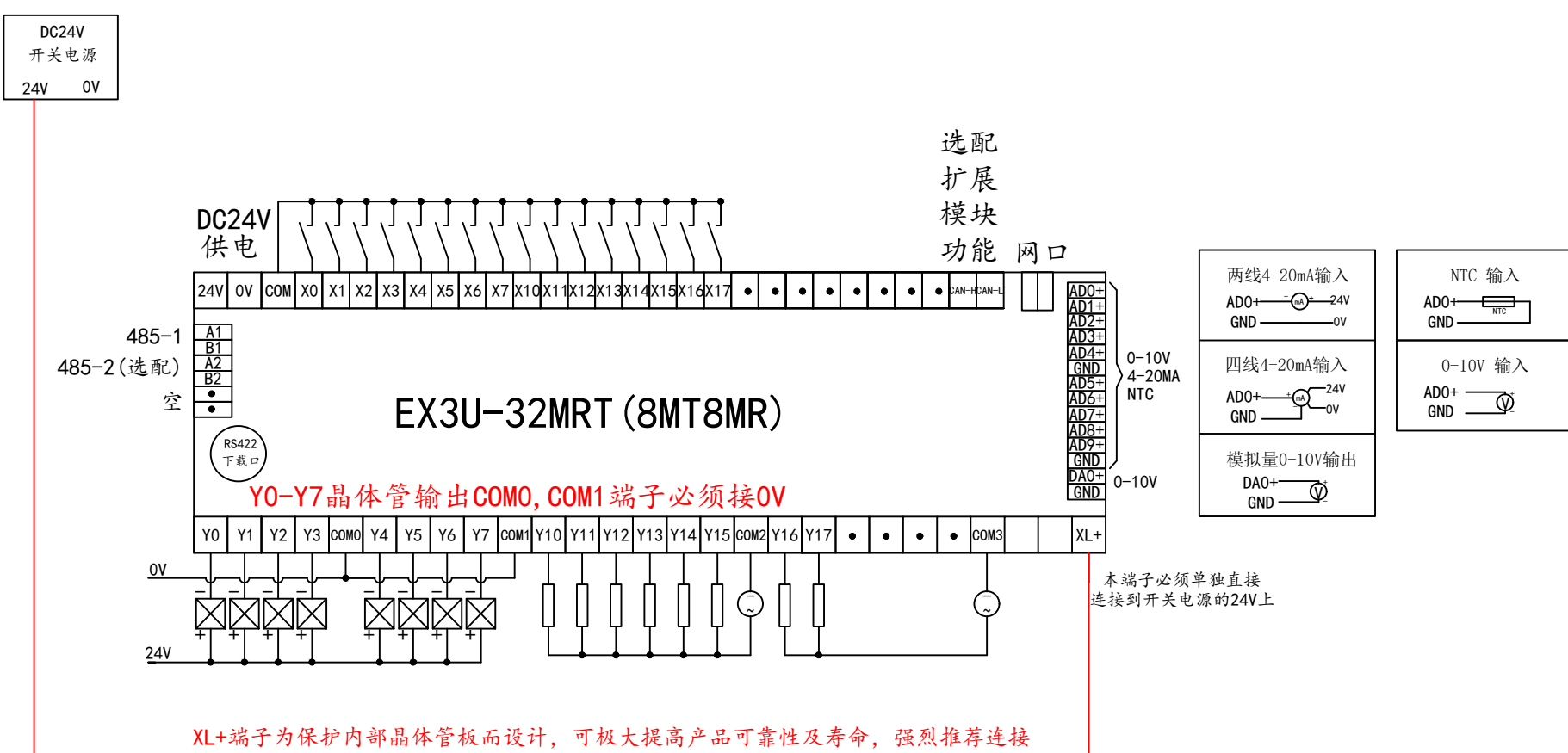
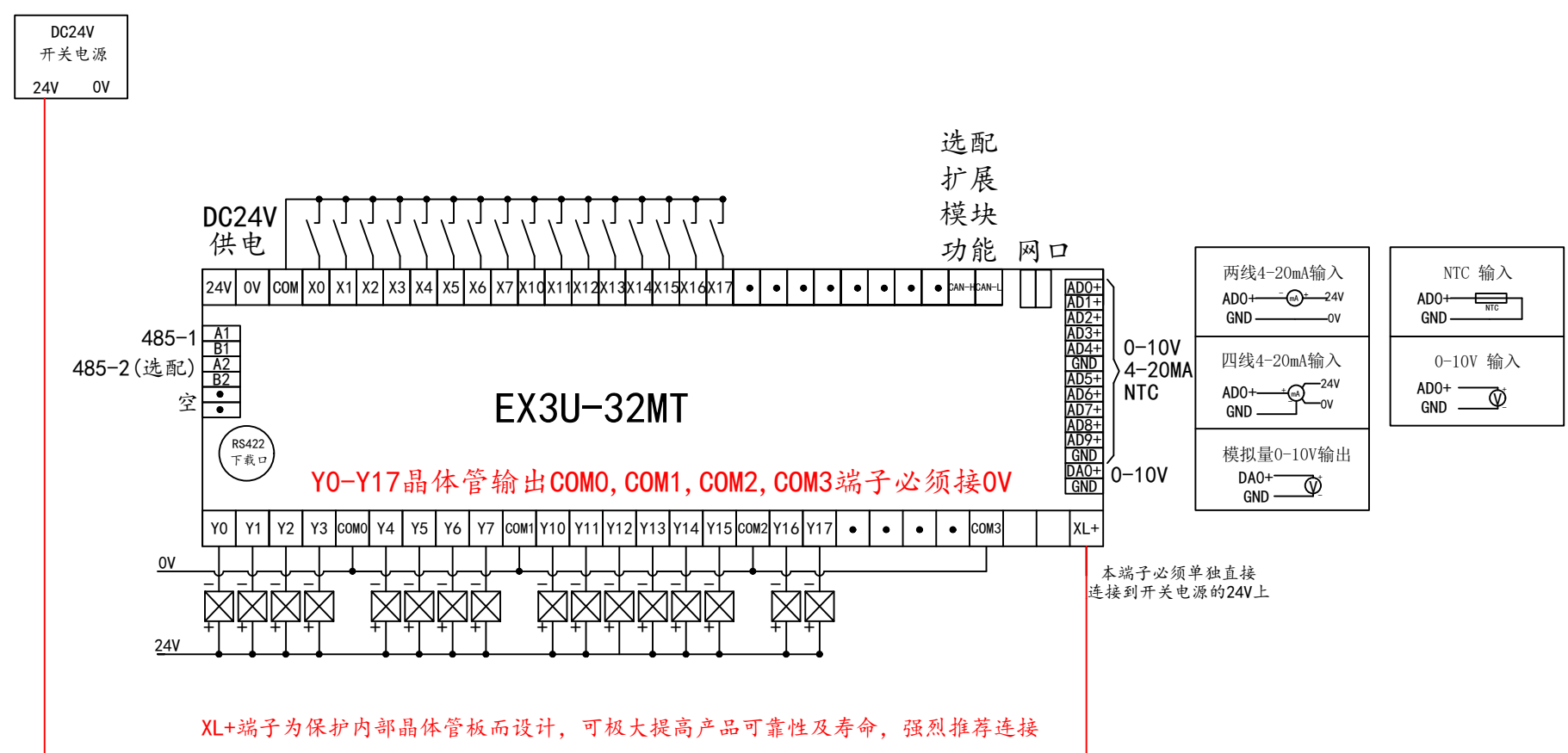
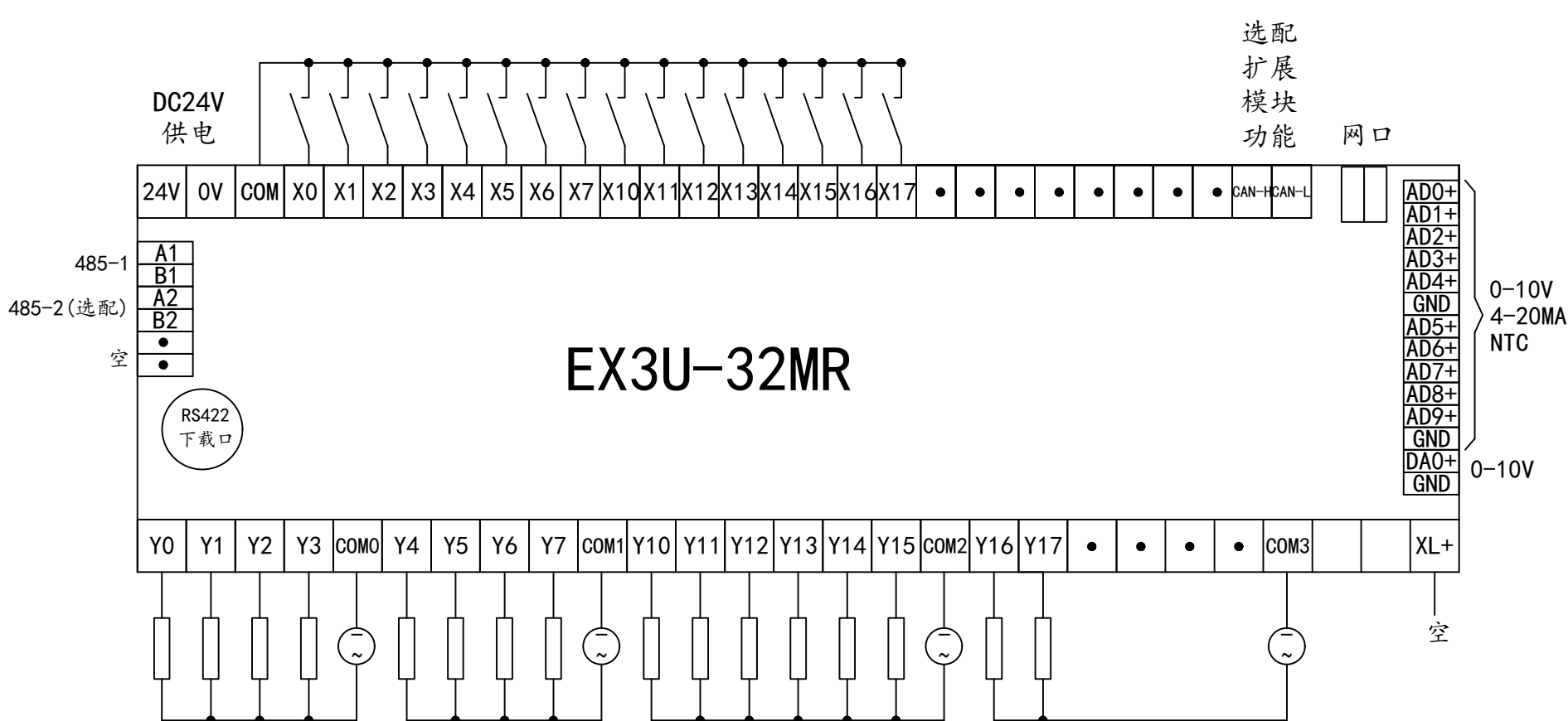

主机型号: EX3U-44MR/MT/MRT

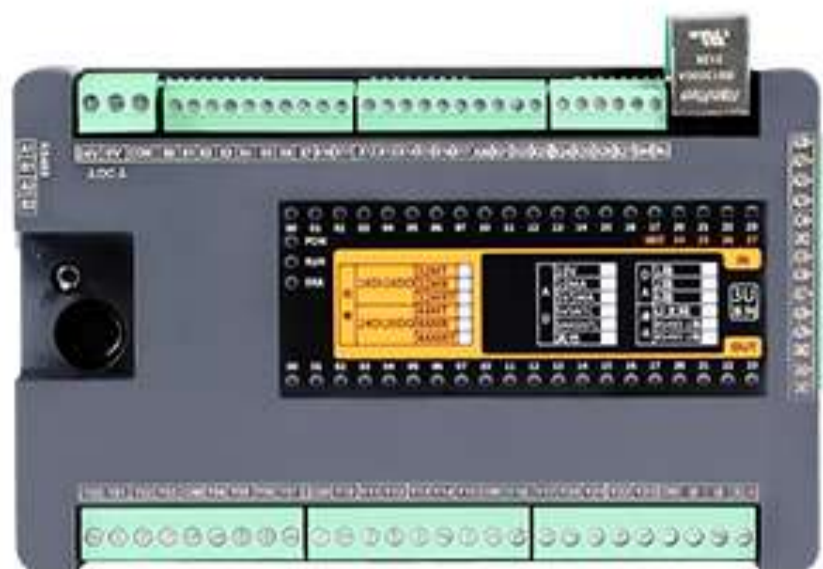

安装尺寸: 166x105x47MM

产品信息	PRODUCT INFO
品牌	易控王 Easycon
产品型号	EX3U-44MR/MT/MRT
供电电压	DC24V
开关量	24进20出
可选配模拟量	10路输入/1路输出
高速脉冲输入	2路110K AB向/单向6路
高速脉冲输出	6轴200K/2轴100高速脉冲输出
可选装	10AD-1DA

### EX3U-44-10AD-1DA接线图

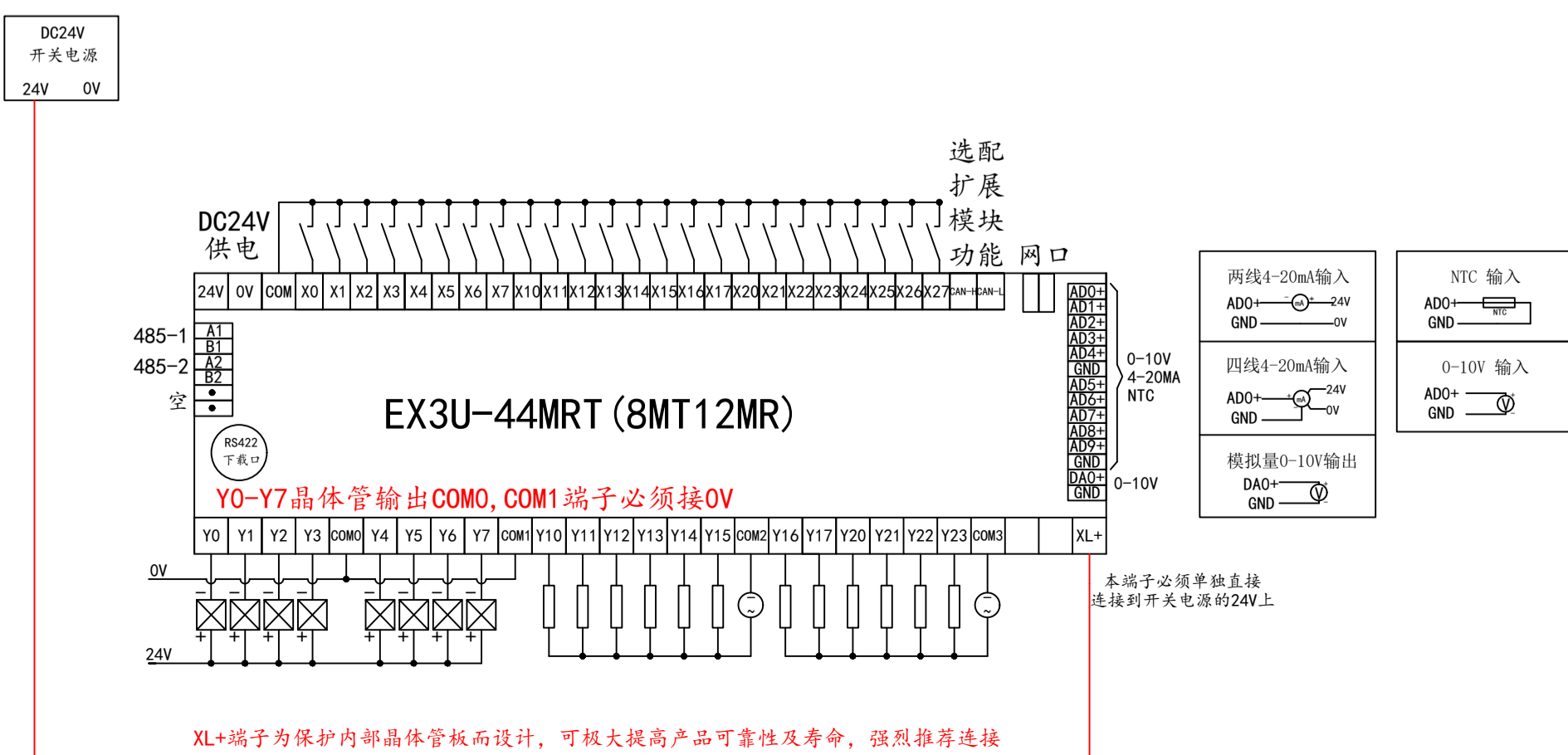
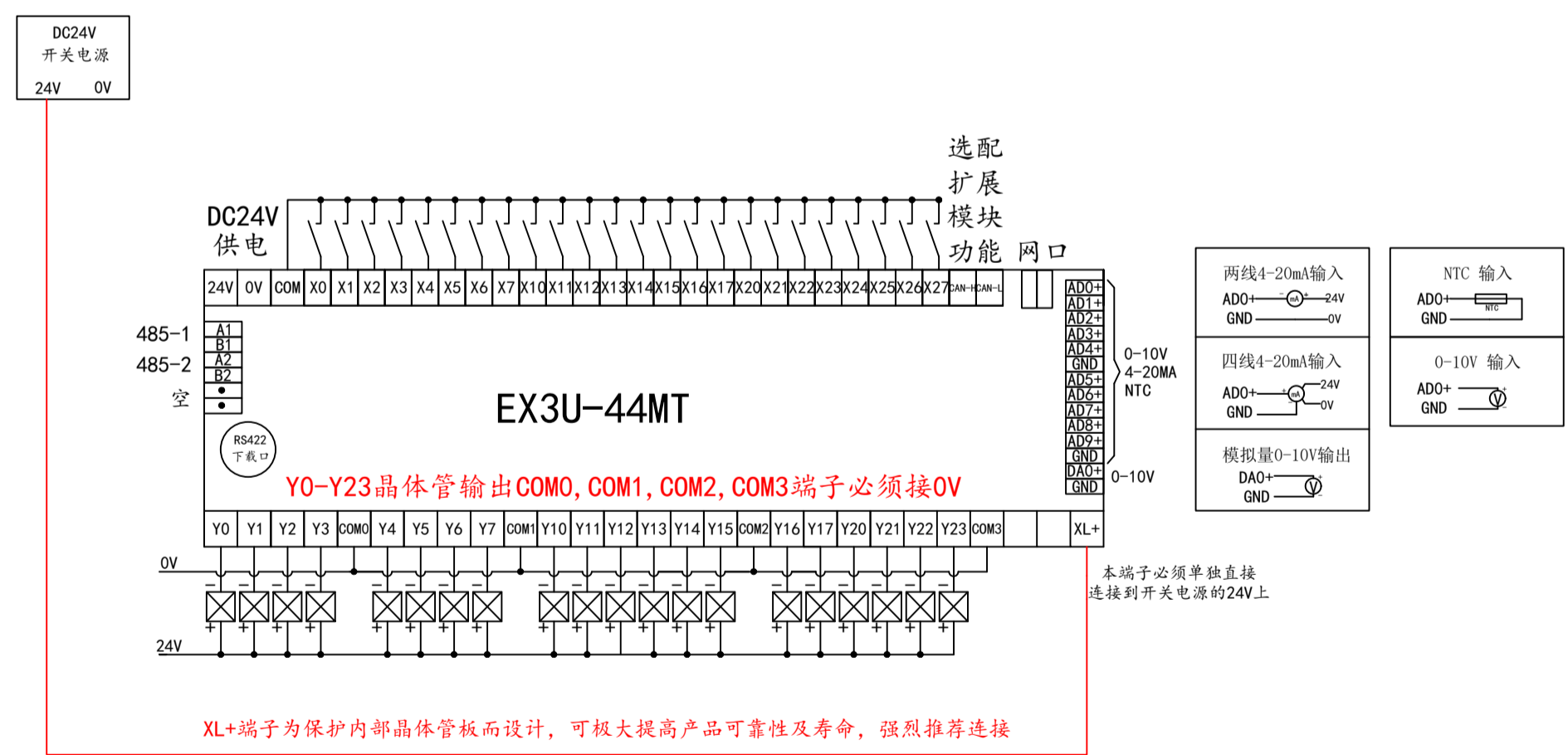
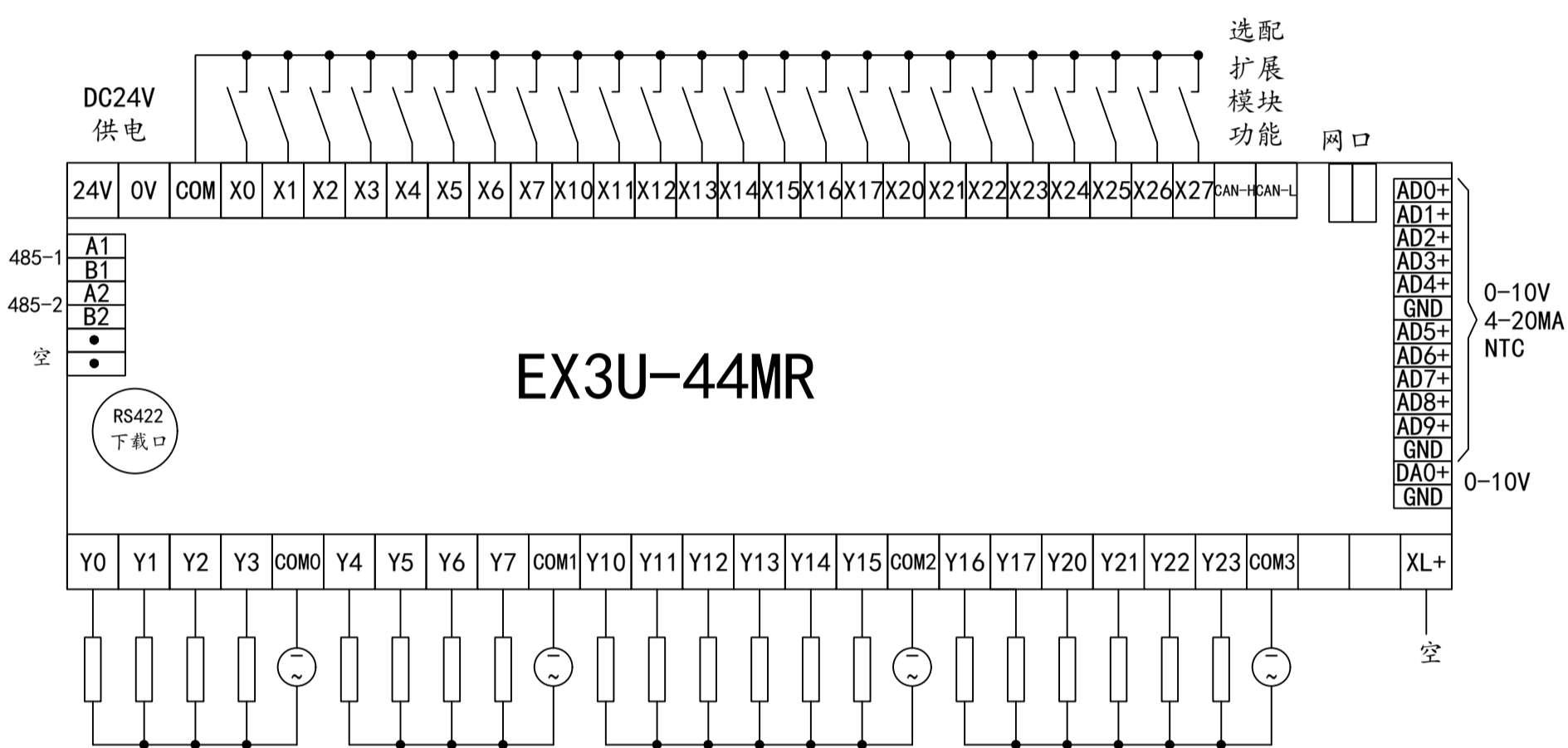

产品信息 PRODUCT INFO	
品牌	易控王 Easycon
产品型号	EX3U-48MR/MT/MRT
供电电压	DC24V
开关量	24进24出
可选配模拟量	10路输入 1/5路输出
高速脉冲输入	2路110K AB向/单向6路
高速脉冲输出	6轴200K/2轴100高速脉冲输出
可选装	10AD-1DA/10AD-5DA

主机型号: EX3U-48MR/MT/MRT

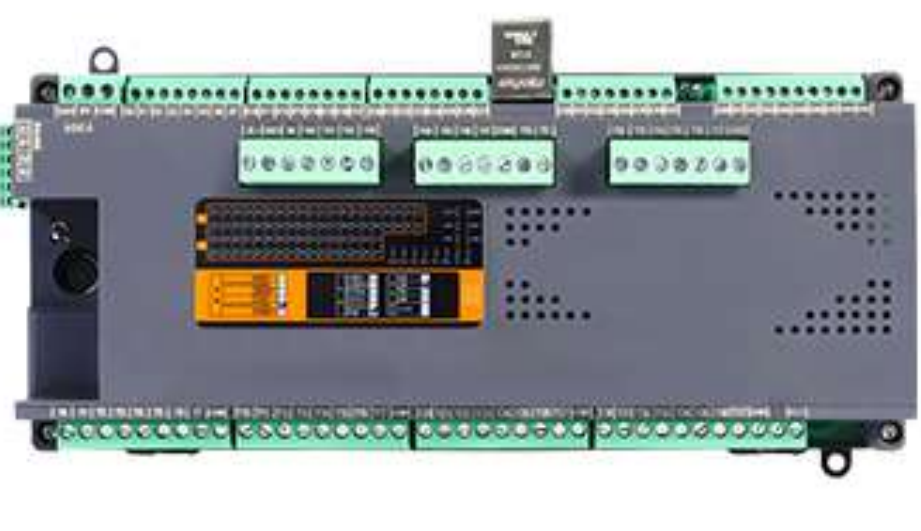

安装尺寸: 240x105x73MM

### EX3U-48-10AD-1DA接线图

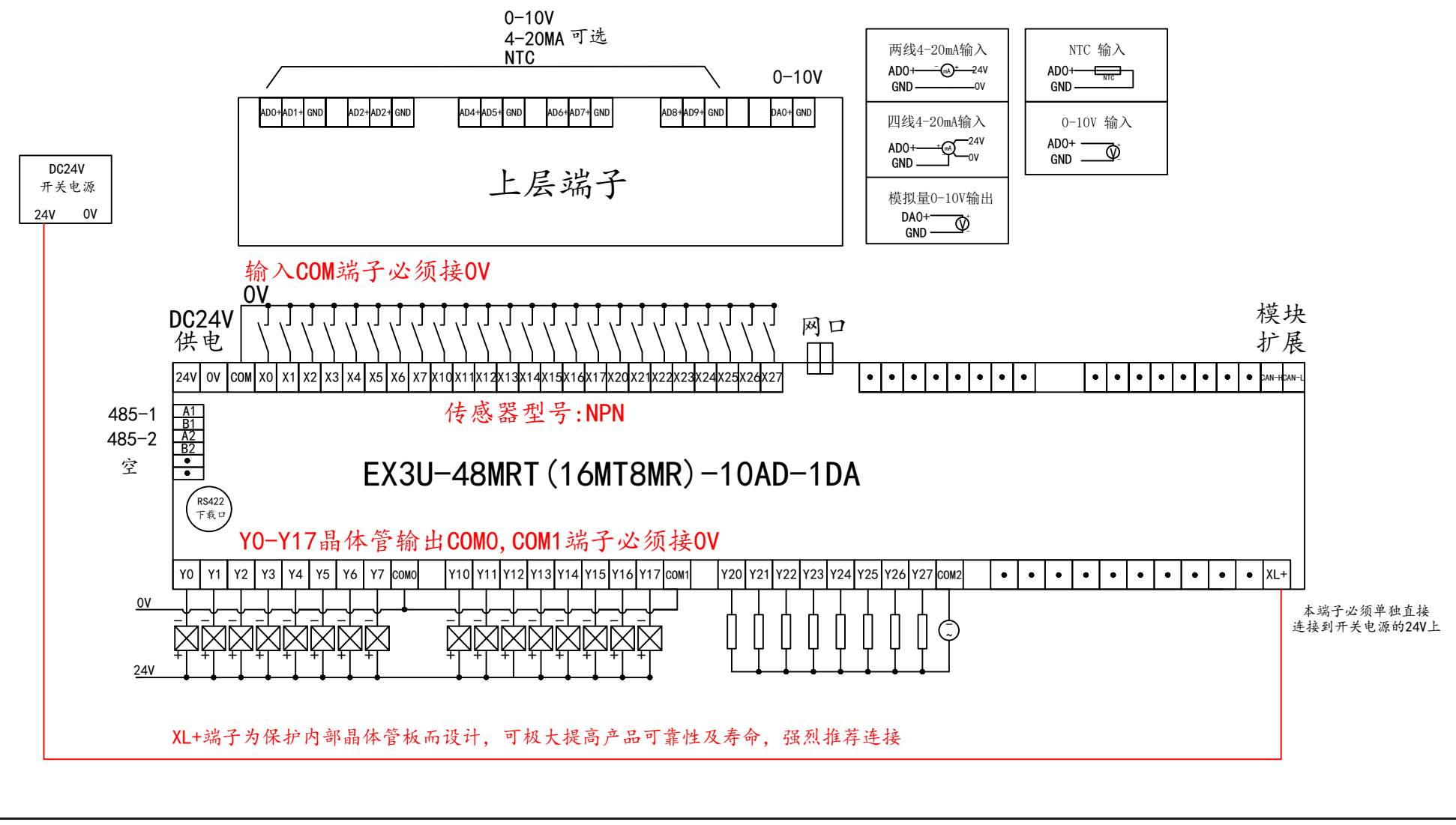
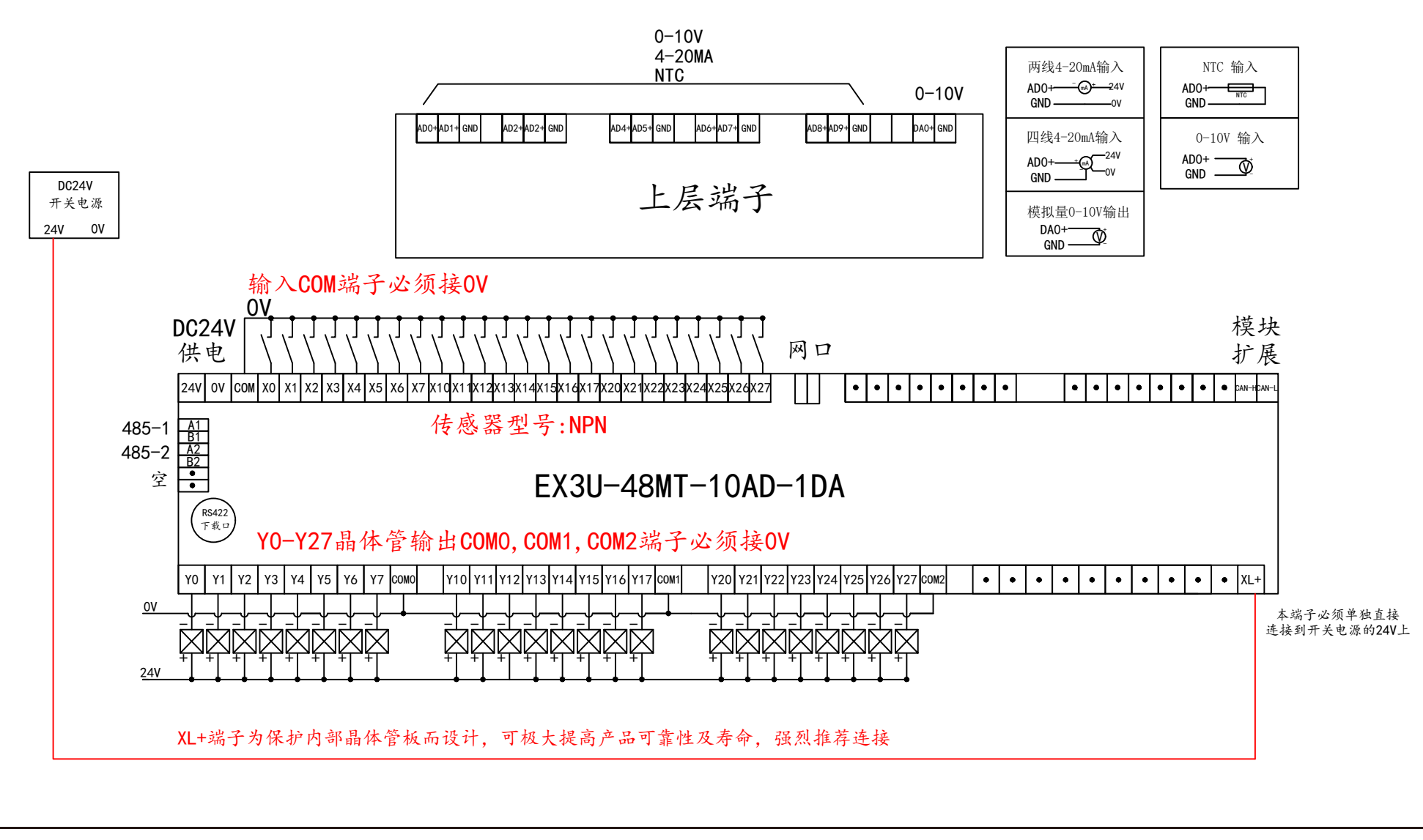
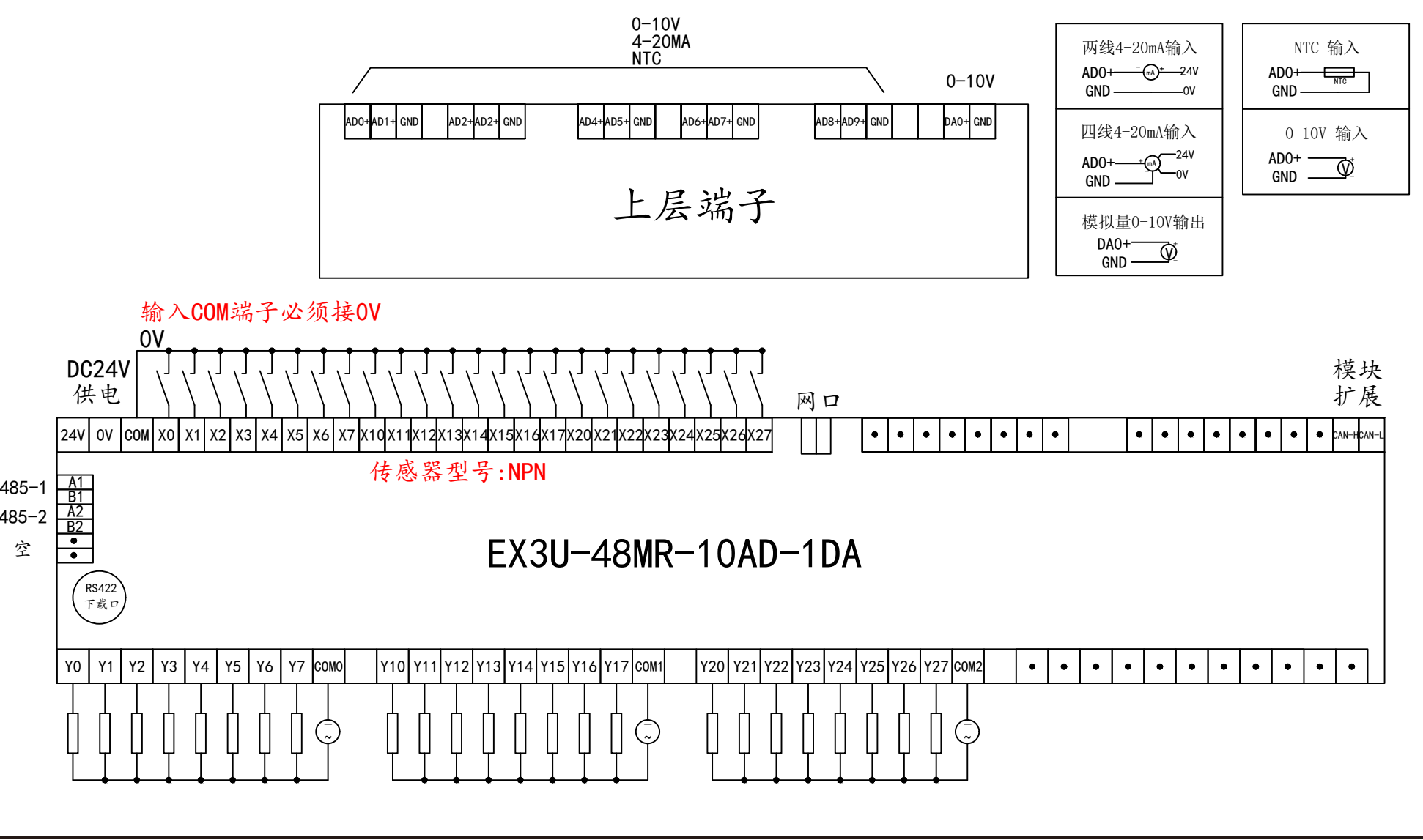

### EX3U-48-10AD-5DA接线图

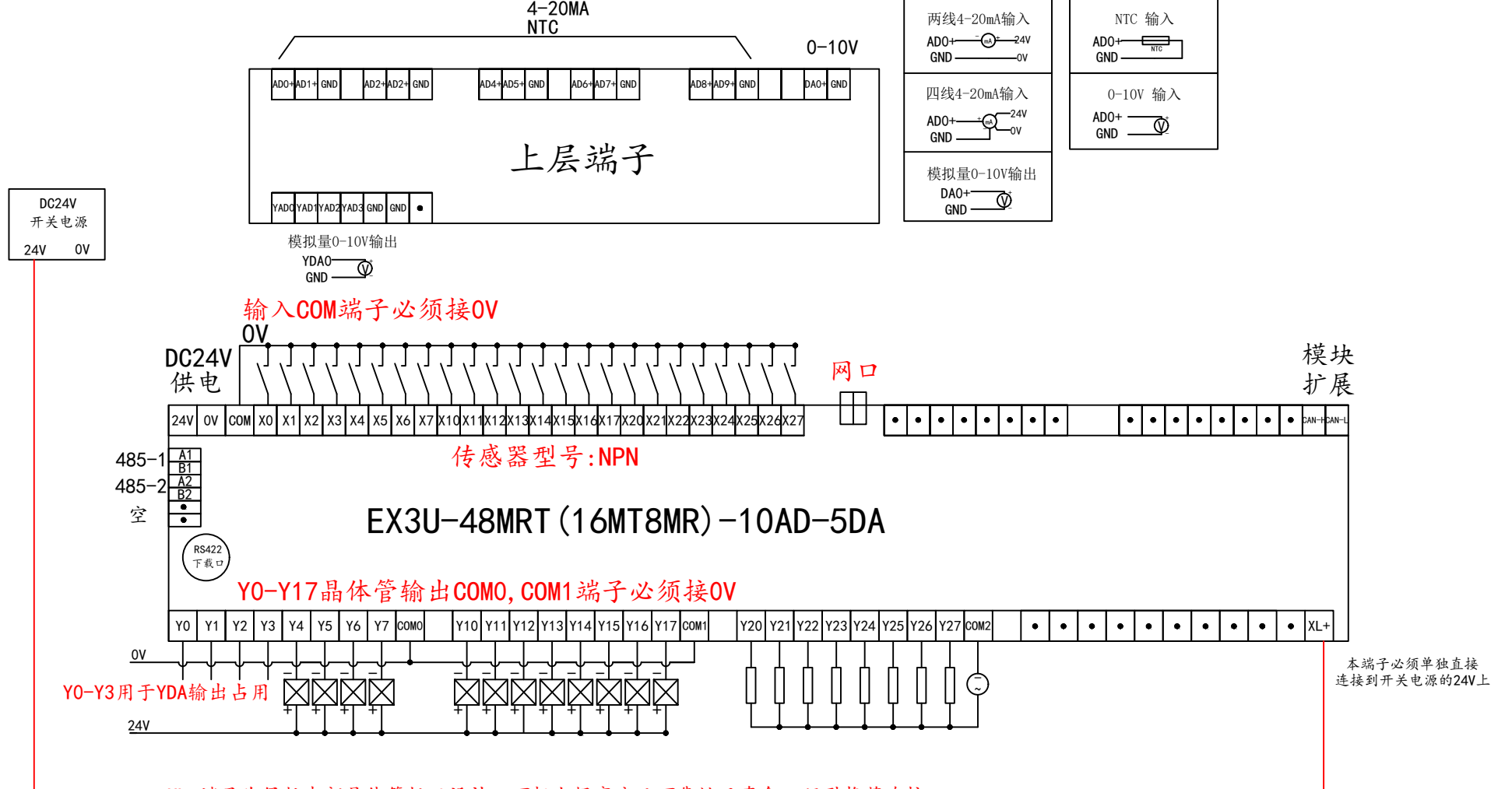
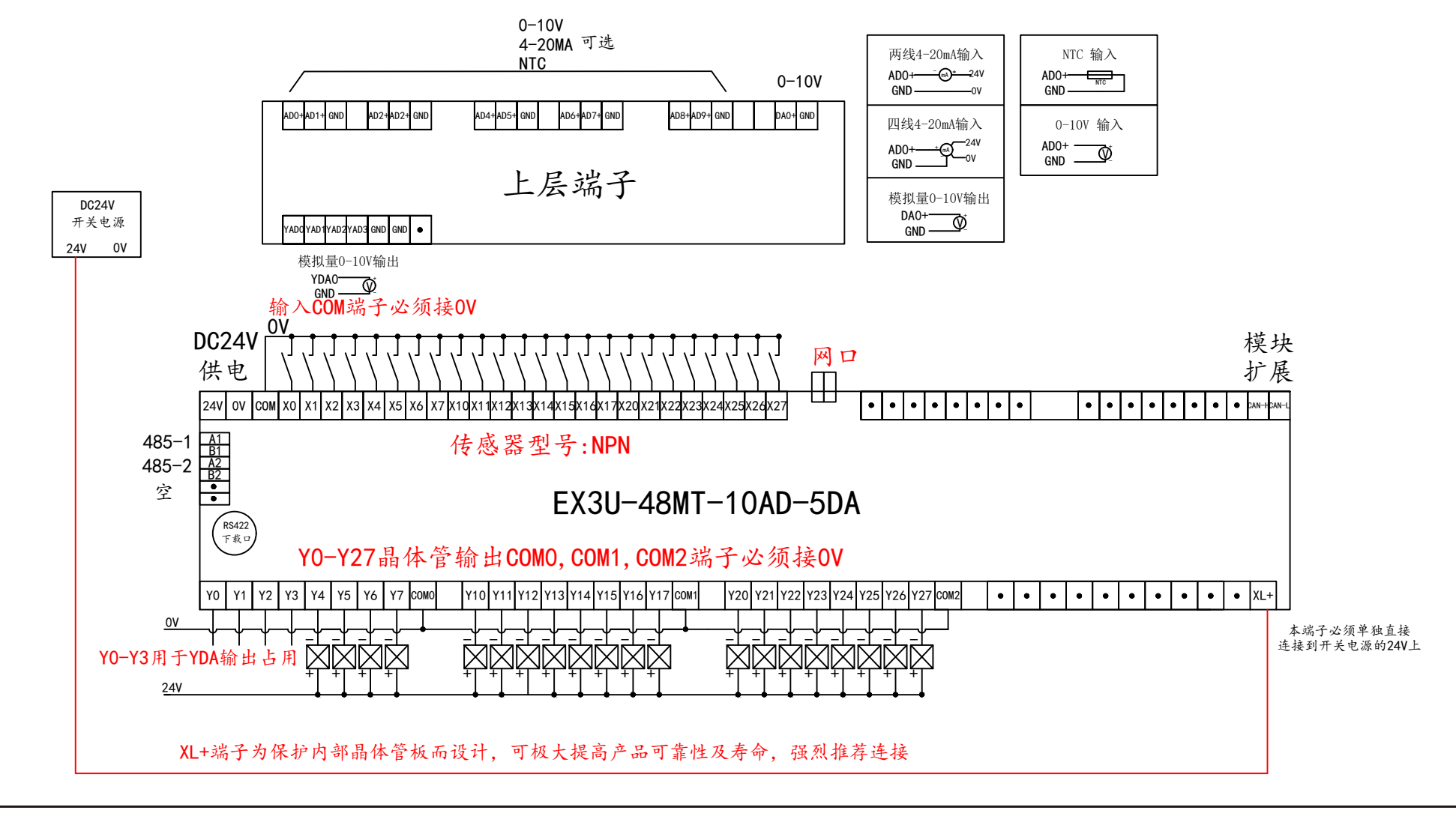
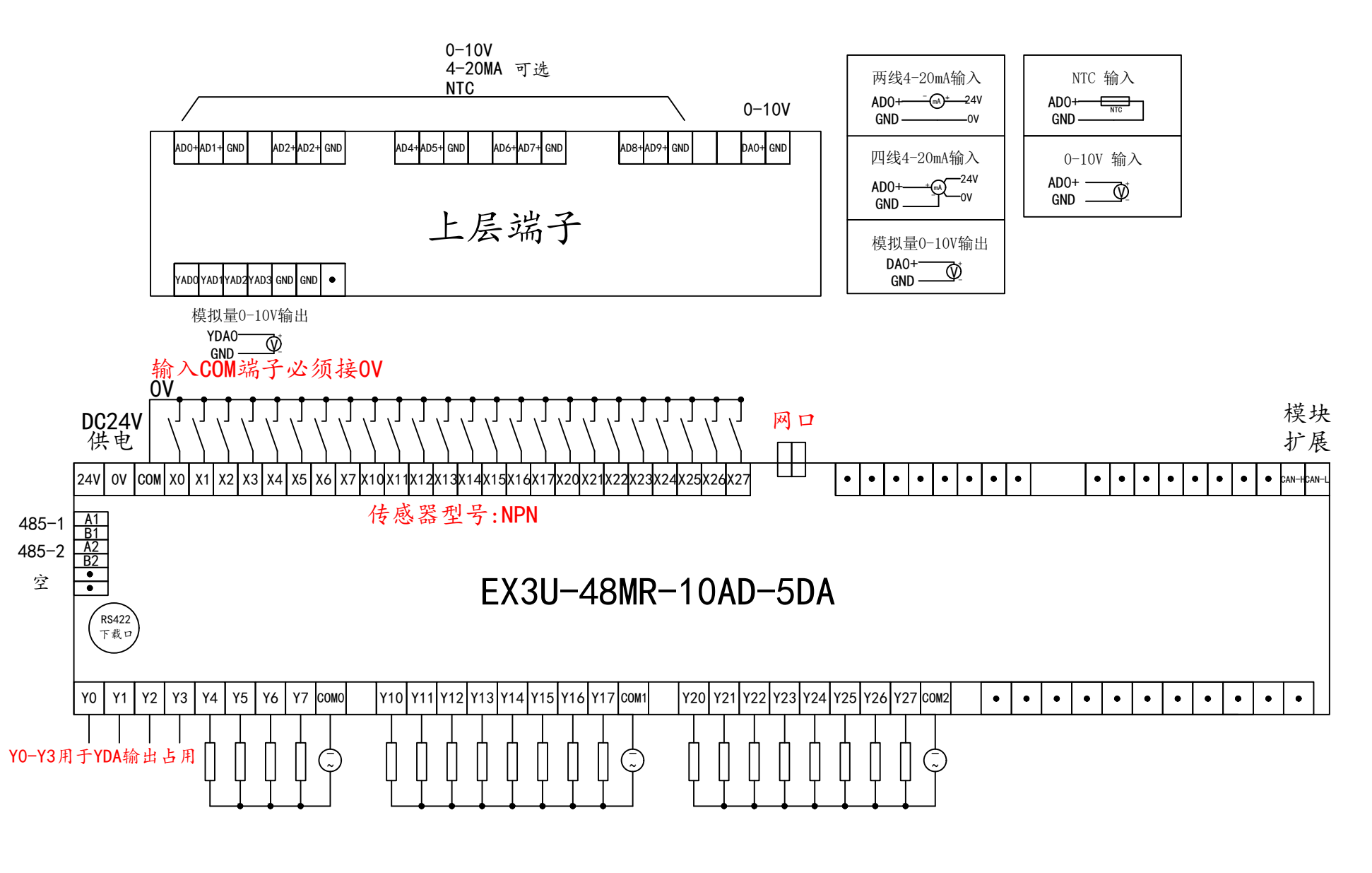

产品信息	PRODUCT INFO
品牌	易控王 Easycon
产品型号	EX3U-72MR/MT/MRT
供电电压	DC24V
开关量	40进32出
可选配模拟量	10路输入 1/5路输出
高速脉冲输入	2路110K AB向/单向6路
高速脉冲输出	6轴200K/2轴100高速脉冲输出
可选装	10AD-1DA/10AD-5DA

主机型号: EX3U-72MR/MT/MRT

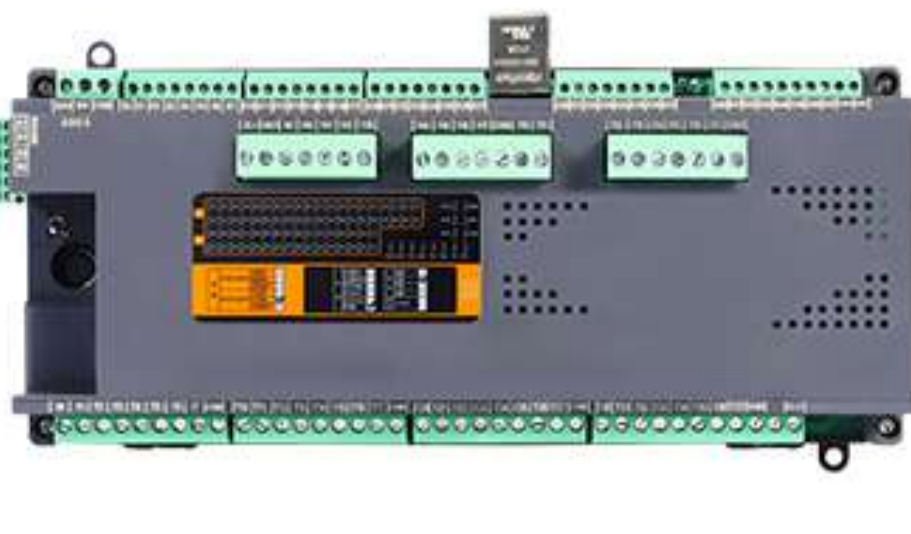

安装尺寸: 240x105x73MM

### EX3U-72-10AD-1DA接线图

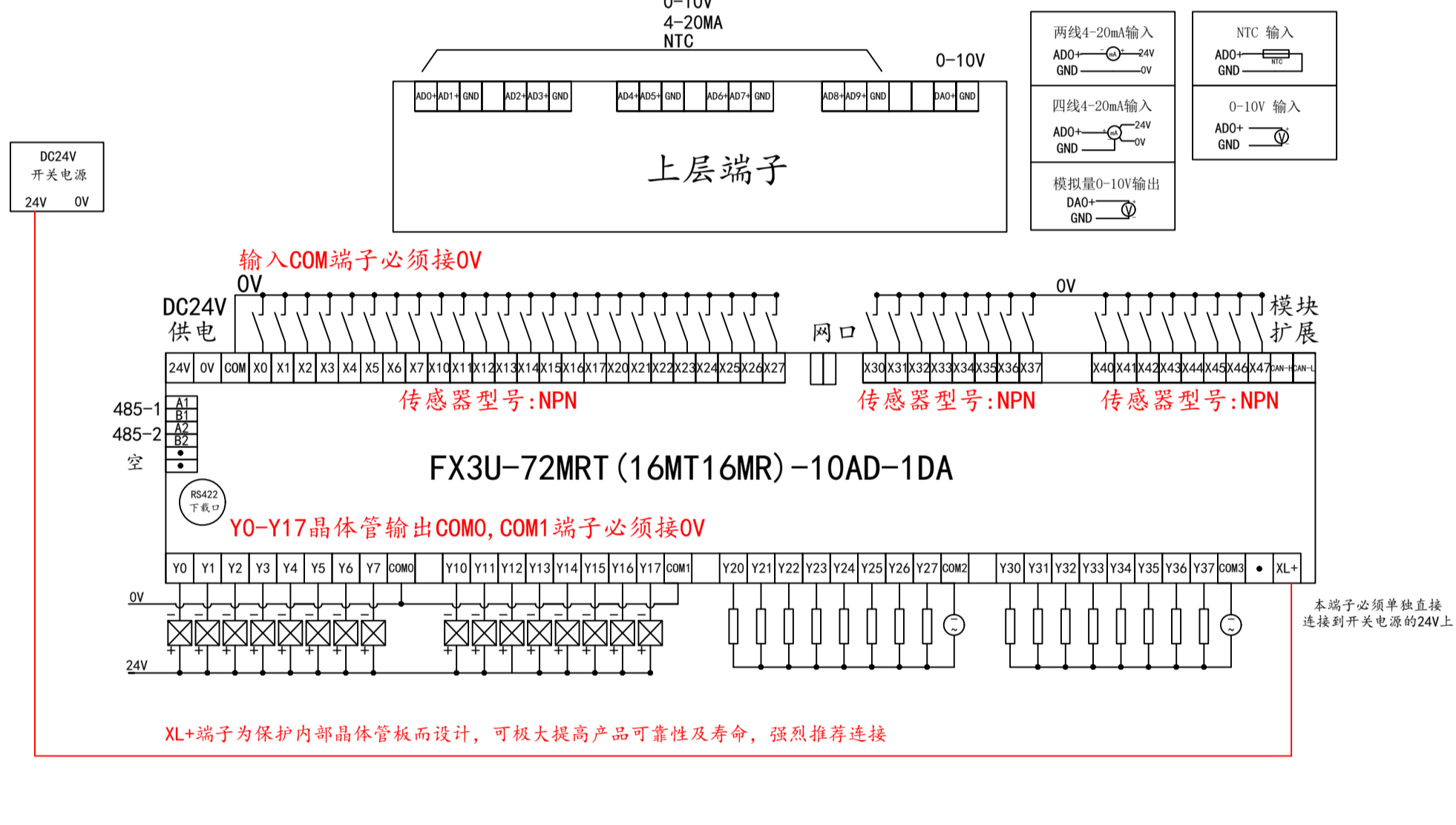
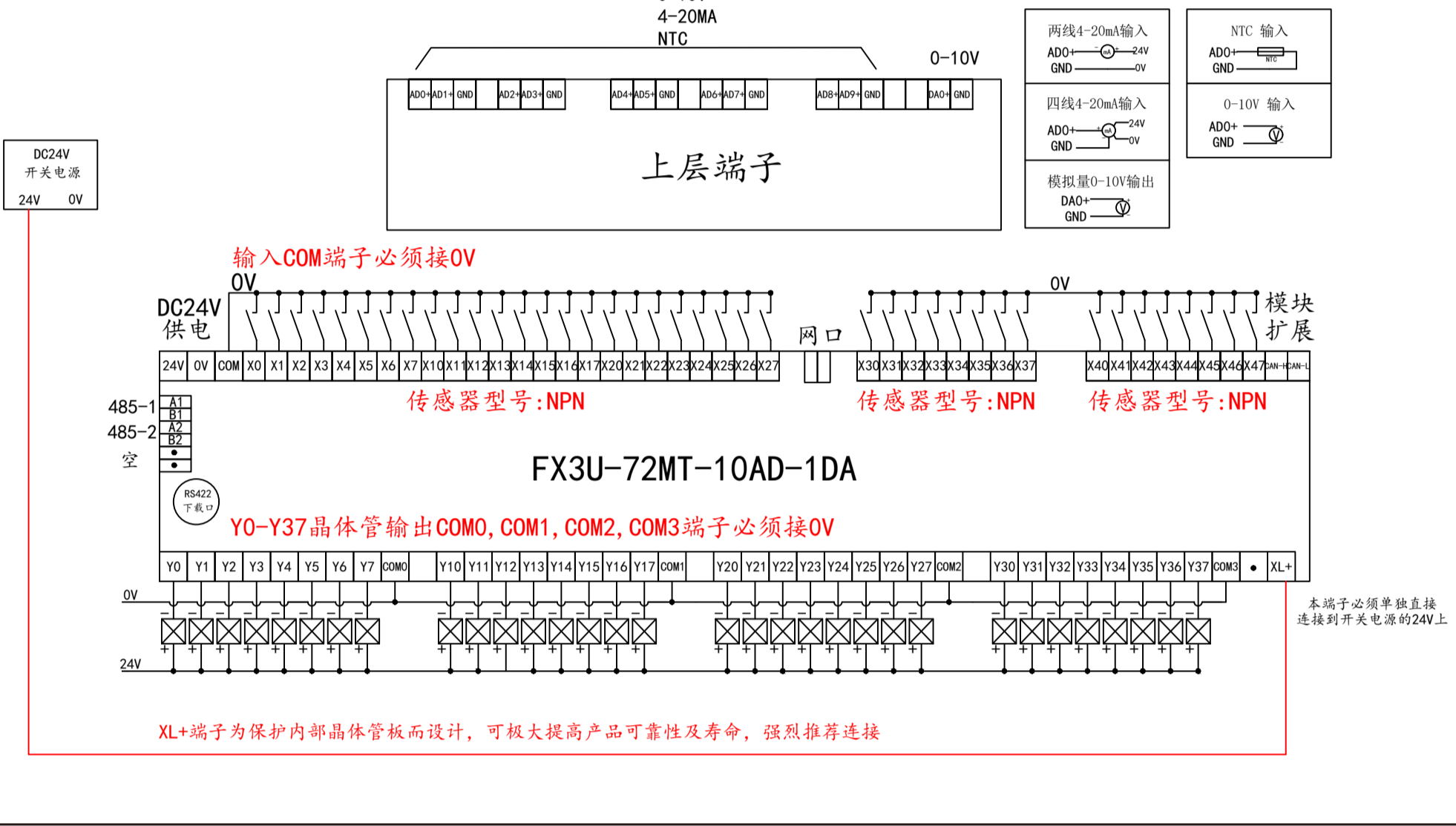
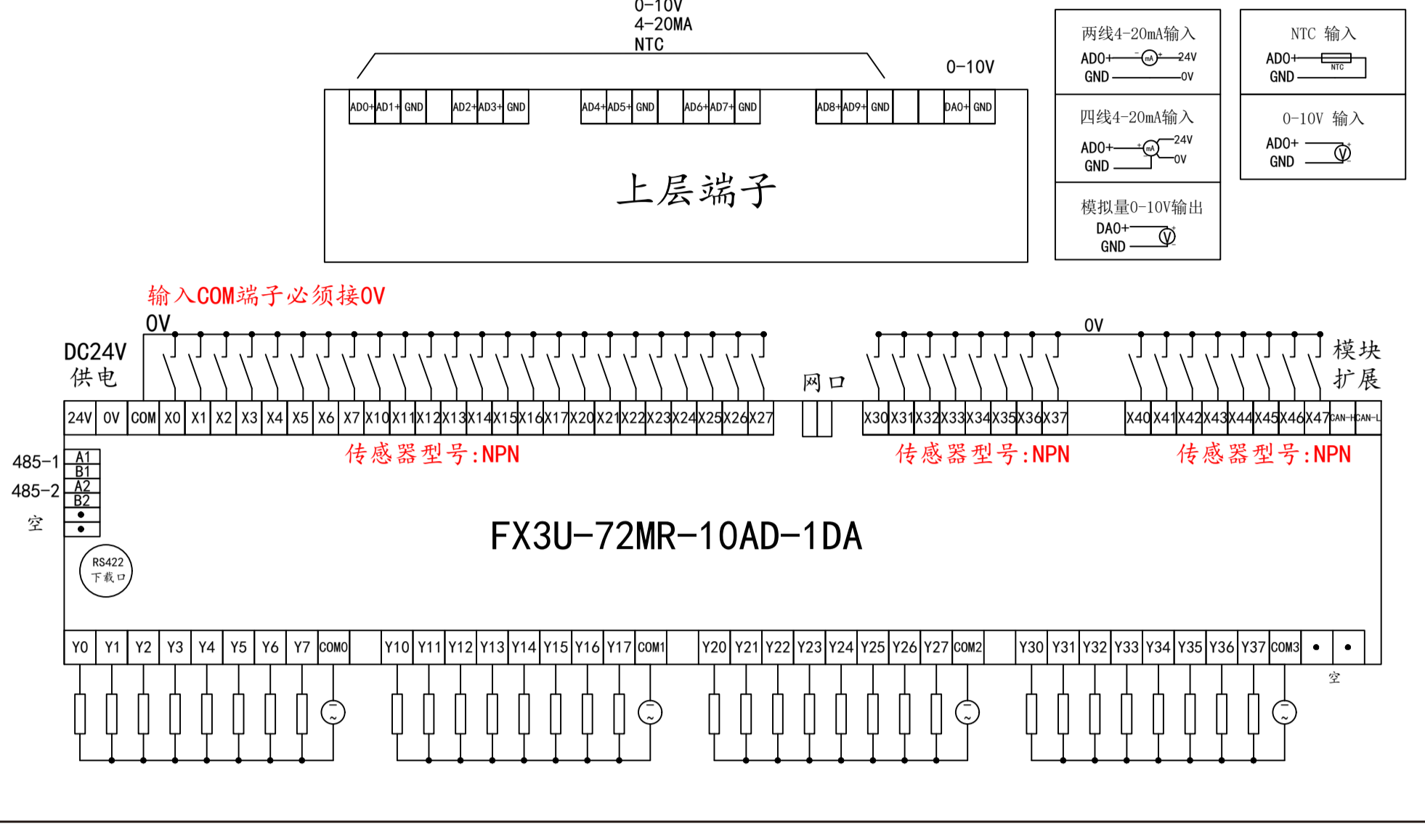

### EX3U-72-10AD-5DA接线图

